

W72×H72mm, Weekly/Yearly Timer

■ Features

- Easy to check and change the program setting
- Customizable weekly or yearly unit time setting and control by user
- Includes daylight saving time function
- Built-in 2 independent control output (relay)
- Flush and surface mounting are in one unit
- Enable to mount on DIN rail with base plate

 Please read "Safety Considerations" in the instruction manual before using.



■ Ordering Information

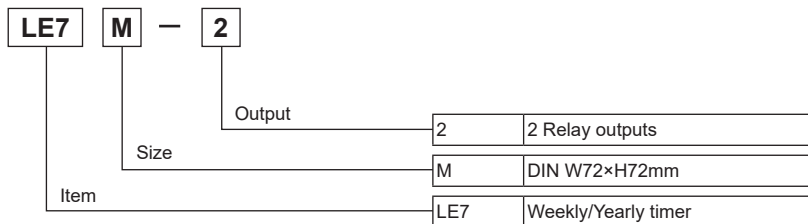

■ Specifications

Model	LE7M-2	
Power supply	100-240VAC~ 50/60Hz	
Allowable voltage range	90 to 110% of rated voltage	
Power consumption	Max. 4.2VA (100-240VAC~)	
RETURN input	Short-circuit or open by switch or relay	
Timing program	48 steps for weekly, 24 steps for yearly	
Operation mode	ON/OFF mode, cycle mode, pulse mode	
Mounting	Front panel, surface, DIN rail	
Time deviation	±15 sec/month (ambient temperature: 25°C) (±4 sec/week)	
Temperature error	±0.01% ±0.05 sec (ratio by set time)	
Memory protection	Over 5 years (at 25°C)	
Control Output	Contact type	SPDT (Single Pole Double Throw)
	Contact capacity	250VAC~ 10A, 30VDC= 5A resistive load
	Output number	Independent 2 output (1c×2)
Relay life cycle	Mechanical	Min. 5,000,000 operations (switching capacity: 30 times/min)
	Electrical	Min. 50,000 operations<switching capacity: 20 times/min, 250VAC 10A (resistive load)>
Insulation resistance	Over 100MΩ (at 500VDC megger)	
Dielectric strength	2,000VAC 50/60Hz for 1 min	
Noise immunity	±2kV the square wave noise (pulse width: 1μs) by the noise simulator	
Environment	Ambient temperature	-10 to 55°C, storage: -25 to 65°C
	Ambient humidity	35 to 85%RH
Approval		
Unit weight	Approx. 272g	

※Environment resistance is rated at no freezing or condensation.

SENSORS
CONTROLLERS
MOTION DEVICES
SOFTWARE

(J) Temperature Controllers
(K) SSRs
(L) Power Controllers
(M) Counters
(N) Timers
(O) Digital Panel Meters
(P) Indicators
(Q) Converters
(R) Digital Display Units
(S) Sensor Controllers
(T) Switching Mode Power Supplies
(U) Recorders
(V) HMIs
(W) Panel PC
(X) Field Network Devices

■ Connections

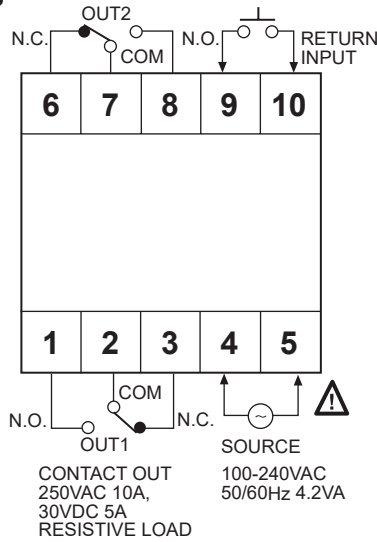

■ Load Connection

You must connect a surge absorber to the both ends of the load to prevent from damage or malfunction of this unit when controlling non-resistive load (E.g.: magnetic switch, etc).

● In case of controlling the load directly

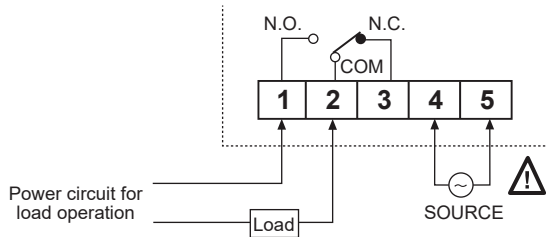

● In case of controlling the load by using a magnetic switch

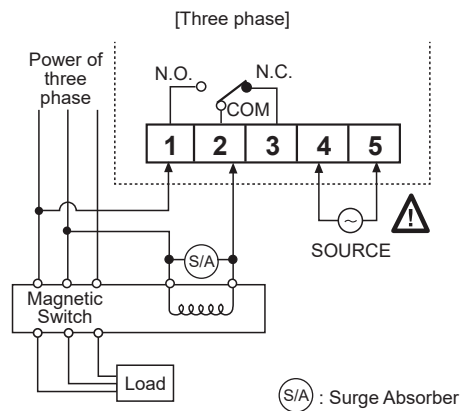
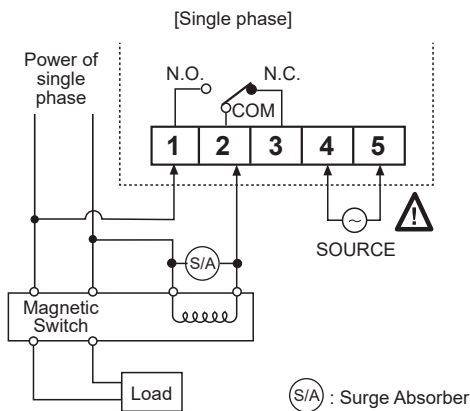

■ Dimensions

(unit: mm)

1) Front panel mounting

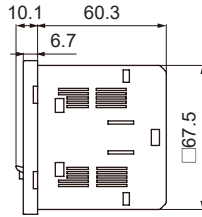
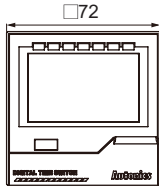

○ Bracket

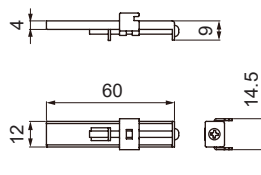

○ Panel cut-out

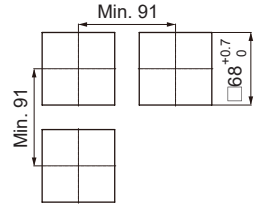

2) Surface mounting

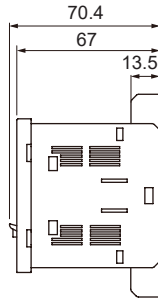
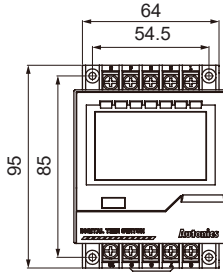

○ Panel hole cut-out

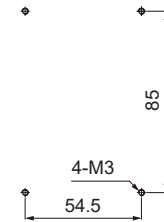

3) DIN rail mounting

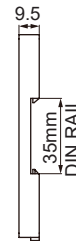
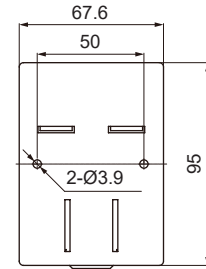
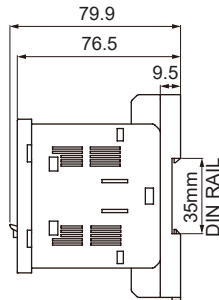
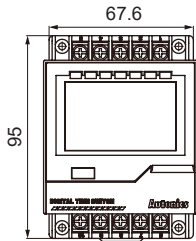

■ How To Switch From The Flush Mounting To Surface Mounting Type

Remove terminals from the body after unscrewing terminal screws, and then assemble terminals to the body after rotating terminals as shown below.

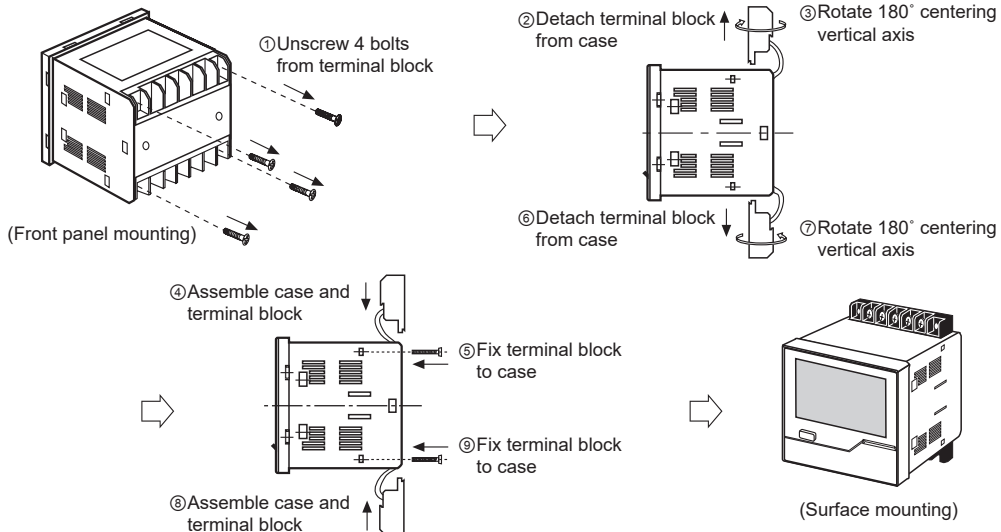

SENSORS
CONTROLLERS
MOTION DEVICES
SOFTWARE
(J) Temperature Controllers
(K) SSRs
(L) Power Controllers
(M) Counters
(N) Timers
(O) Digital Panel Meters
(P) Indicators
(Q) Converters
(R) Digital Display Units
(S) Sensor Controllers
(T) Switching Mode Power Supplies
(U) Recorders
(V) HMIs
(W) Panel PC
(X) Field Network Devices

■ Unit Description

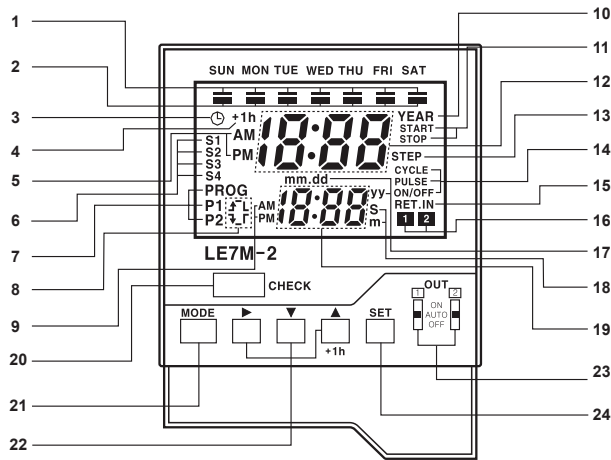

1. Day indicator
2. Day display
 - Light: Day is selected.
 - Light-out: Day is not selected.
3. Current time setting mode indicator
4. DST display (daylight saving time)
5. AM/PM display
6. Season display
7. Program display
8. Display ON time/day, OFF time/day, ON time width, OFF time width
9. AM/PM display
10. YEAR display
 - : It turns ON when set, check, modify, delete yearly program, set yearly holidays and operate yearly program.
11. Yearly START/STOP day display
12. Main display

13. Remaining step display
14. Operation mode display
15. Power restore input display
16. Output mode display
17. Year, month, date display
18. Unit of pulse width display
19. Sub-display
20. CHECK key
21. MODE key
22. Operation key
23. Output selection switch
 - AUTO: Control output according to the set program.
 - ON: Output is ON. (operation)
 - OFF: Output is OFF.
 - ※ Output 1 (OUT1) and Output 2 (OUT2) are selected independently.
24. SET key

■ Functions

◎ **Program setting and output operation**
Output 1/Output 2 operates according to Program 1 and Program 2.

◎ Definitions

- Record: A part of program that controls output operation.
- Step: Basic component of record.

◎ Operation modes

If the operation mode of Program 1 (program 2) is set on pulse mode initially, the pulse mode is fixed for additional programs.

If the operation mode of Program 1 (program 2) is set on ON/OFF or cycle mode initially, pulse mode cannot be used for additional programs.

- Weekly ON/OFF mode
Output operation by ON/OFF set time.
- Min. time setting unit: 1 min
- It is able to set ON/OFF day separately.
- One record in two Steps
(ON day/ON time, OFF day/OFF time)



- Weekly Cycle mode
Output turns ON for ON time and turns OFF for OFF time. And the ON/OFF cycle is repeated.

- Set range for ON/OFF time width
: 1min to 12 hour 59 min
- One record in 3 steps (ON day/ON time, OFF day/OFF time, ON time width/OFF time width)

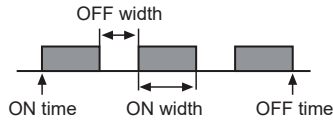

- Weekly pulse mode
Output turns ON at ON time for a specified pulse width. (pulse width: 1 to 59 sec, 1 to 60 min)
- One record in two steps (ON day/ON time, pulse width)

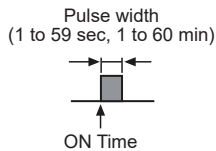

- Yearly ON/OFF mode
Output turns ON at ON time on START date and turns OFF at OFF time on STOP date.
- One record in three steps (START/STOP date, ON/OFF time)
- Yearly pulse mode
Output turns ON at ON time on START date and turns OFF at OFF time on STOP time for a specified pulse width repeatedly. (pulse width: 1 to 59 sec, 1 to 60 min).
- One record in three steps (START/STOP date, ON time, pulse width)

◎ Program operation

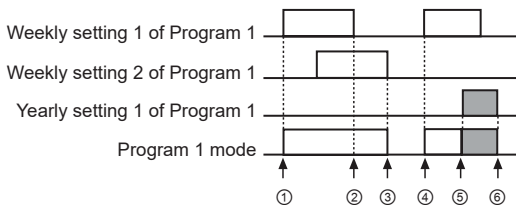

- ① to ②: Operated by weekly setting 1 of Program 1.
- ② to ③: Operated by weekly setting 2 of Program 1.
- ④ to ⑤: Operated by weekly setting 1 of Program 1.
- ⑤ to ⑥: Operated by yearly setting 1 of Program 1. (during weekly program operation at 12:00 AM on START date, the weekly program operation stops, and it changes to yearly program operation mode. The yearly program operation stops at 12:00 AM on the next day of STOP date.)

◎ Display and change of next mode

- The day of next mode in Program 1 or Program 2 is displayed on the day indicator, and the time of next mode is displayed on the lower row of screen.
Press **[SET]** + **[CHECK]** in RUN mode it is changed from program 1 to program 2 or from program 2 to program 1.
- In ON/OFF operation mode, set ON time and OFF time to next mode. In Pulse operation mode, set Pulse ON time to next mode.

◎ Power restore mode

In setting group 2-Level 2 (power restore), select auto [Rt] or normal [nor] by **[▲]** or **[▼]** key, and press **[SET]** key to set.

- Auto [Rt] power restore mode
Output (OUT1, OUT2) operates according to program when power turns on again after power failure.
- Normal [nor] power restore mode
When power turns on again after power failure, output is kept OFF and **RET.IN** flashes on the panel. When power restore input is detected, **RET.IN** turns off and output operates according to program.
- Power restore input
Input contact signal in external "Return input terminals (⑨ to ⑩)" by switch or relay, or press **[SET]** key for 3 sec in RUN mode.
Please use reliable contacts enough to flow 0.1mA of current at 5VDC when use switch or relay.

◎ Season switching mode

This feature uses for setting seasonal weekly operation mode.

To operate this mode, save starting month and date, ending month and date of each season which displays S1, S2, S3, S4 then set day and time of each season in weekly program setting. It is also able to operate only in summer and winter season. (S1: set summer season, S2: set winter season, S3/S4: do not set)

At the season switching selection LEVEL 2 status in setting 2 group (SEn turns ON, OFF flashes), select ON [on] by pressing **[▲]** or **[▼]** key and press **[SET]** key to complete the season switching.

Be sure that if changing season switching from OFF to ON or, ON to OFF, the weekly program 1 (P1) and the weekly program 2 (P2) which are set before are deleted.

- ON [on] mode
Weekly program is switched automatically by season switching.
- Period setting per season
 - ① At the season switching selection LEVEL 2 status in setting 2 group (SEn flashes, the set season turns ON, **START** and **STOP** turn ON), press **[SET]** key.
 - ② Advance to the flashing position of season selection among S1, S2, S3, S4 by **[▲]** or **[▼]** key and press **[SET]** key.
 - ③ After set START month, date per season and press **[SET]** key.
 - ④ **[SET]** key is pressed after set STOP month, date per season, it is advanced to LEVEL1 of period setting per season. Add or adjust the period setting by **[SET]** key.
- It is disable to use when it is OFF [OFF].
- If season terms are overlapped, these are prioritized in S4>S3>S2>S1 order.

SENSORS
CONTROLLERS
MOTION DEVICES
SOFTWARE
(J) Temperature Controllers
(K) SSRs
(L) Power Controllers
(M) Counters
(N) Timers
(O) Digital Panel Meters
(P) Indicators
(Q) Converters
(R) Digital Display Units
(S) Sensor Controllers
(T) Switching Mode Power Supplies
(U) Recorders
(V) HMIs
(W) Panel PC
(X) Field Network Devices

☉ Daylight saving time

To utilize daylight during the summer season, daylight saving time is adjusted forward one hour from standard time.

In setting group 2-LEVEL 2 (d5t turns ON, flt or nor flashes.), select Auto [flt] or Normal [nor] by ▲ or ▼ key and press **SET** key to set.

- Auto[flt] Daylight Saving Time mode

Current time will be faster as an hour when it is started and slower as an hour when it is finished.

- Automatic Daylight Saving Time period setting

- ① Automatic Daylight Saving Time period setting LEVEL 1 of setting group 2. (d5t flashes and **START** and **STOP** turn ON.)

- ② Set **START** date (month, date) of automatic Daylight Saving Time mode and press **SET** key.

- ③ Set **START** time (AM/PM, hour) of automatic Daylight Saving Time mode and press **SET** key.

But, the minute will be fixed as 00.

- ④ Set **STOP** date (month, date) of automatic Daylight Saving Time mode and press **SET** key.

- ⑤ Set **STOP** time (AM/PM, hour) of automatic Daylight Saving Time mode and press **SET** key. But, the minute will be fixed as 00.

- Normal [nor] daylight saving time mode

Press **+1h** key over 3 sec in RUN mode, **+1h** turns ON and current time is faster as an hour and **+1h** turns ON out or vice versa, when press **+1h** key over 3 sec again.

☉ Current time setting

(E.g.) Set the current time as 10, Mar, 2008, 5:10 PM.

① Advance to the current time setting mode

SUN MON TUE WED THU FRI SAT



MODE + **SET** keys are pressed over 3 sec in RUN mode, it is advanced to current time setting of setting group 2 and clock will be flashed and E.AJ will be lighted in second display part, press **SET** key.

② Year, month, date setting

SUN MON TUE WED THU FRI SAT

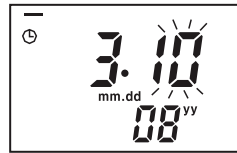

Press ▲ or ▼ key to set 08 (year 2008) and move the flashing digit to position month by ► key.

Press **SET** key after press ▲ or ▼ key to set date 10.

③ Current time (AM, PM) setting

SUN MON TUE WED THU FRI SAT



Press ▲ or ▼ key to select PM and move the flashing digit to position hour by ► key.

④ Current time (hour, min) setting

SUN MON TUE WED THU FRI SAT



Press ▲ or ▼ key to set 5 PM and move the flashing digit to position min by ► key. Press ▲ or ▼ key to set 10 min and press **SET** key and it is returned to RUN mode when press **MODE** key over 3 sec

- It advances to "①Current time setting mode" in ON status and set current time as shown above ② to ④ by **SET** key.
- Current time is set up to 31, Dec., 2099.
- Check current year/month/date in RUN mode When ► key is pressed over 3 sec in RUN mode, it advances to current year/month/date display. After display current year/month/date for 3 sec, it returns to RUN mode displaying current display.

■ Program Setting

○ Setting group 1

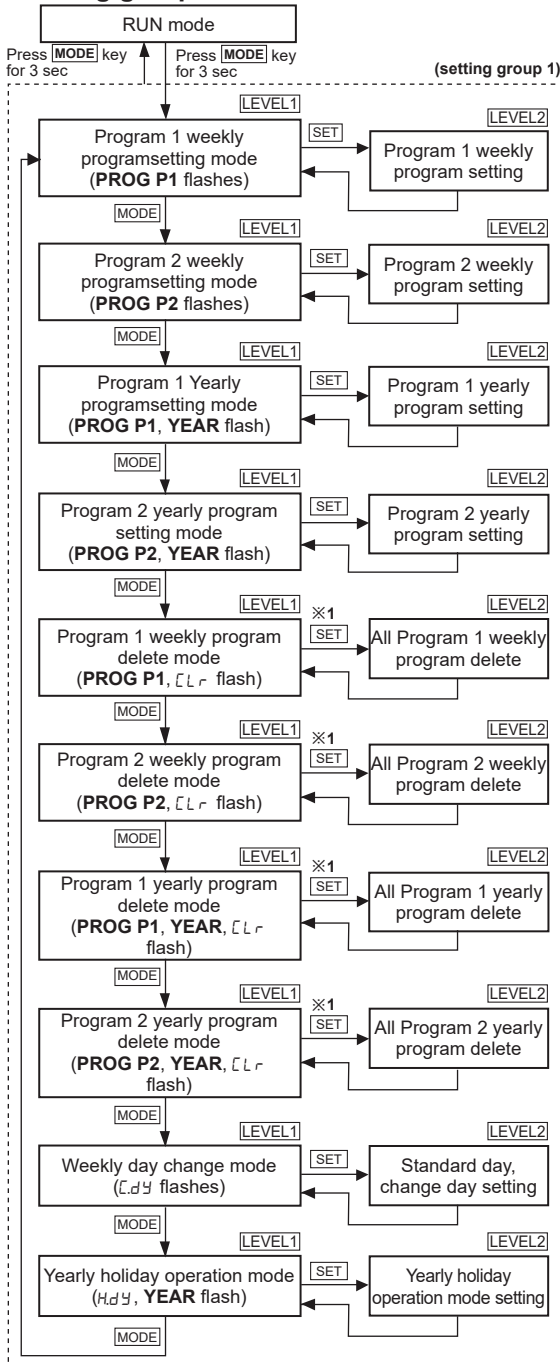

※1: When the CLR turns ON, hold the SET key for 3 sec, the ALL turns ON and all programs are deleted.

- When it advances to setting group 1 in RUN mode, output (OUT1, OUT2) will be OFF.
- It returns to previous setting group 1 when power of time switch is ON again in setting group 1.
- When **MODE** key is pressed in LEVEL2 of setting group 1, current setting will be canceled and it returns to previous LEVEL1.

○ Setting group 2

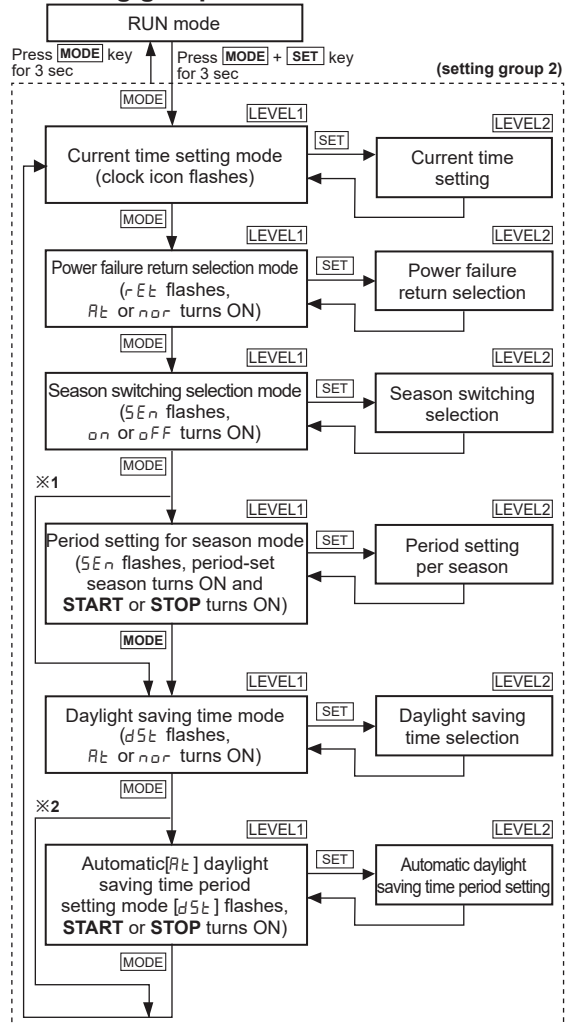

※1: Season switching selection is oFF.

※2: Automatic switching selection of Daylight Saving Time is Normal [nOr].

- When it advances to setting group 2 in RUN mode, output (OUT1, OUT2) will be OFF.
- When power of time switch is ON again in setting group 2, it returns to previous setting group 1.
- Front **MODE** key is pressed in LEVEL2 of setting group 2, it returns to previous LEVEL1.
- When season switching selection is changed from oFF to on or on to oFF, previous set weekly program will be deleted.

SENSORS
CONTROLLERS
MOTION DEVICES
SOFTWARE
(J) Temperature Controllers
(K) SSRs
(L) Power Controllers
(M) Counters
(N) Timers
(O) Digital Panel Meters
(P) Indicators
(Q) Converters
(R) Digital Display Units
(S) Sensor Controllers
(T) Switching Mode Power Supplies
(U) Recorders
(V) HMIs
(W) Panel PC
(X) Field Network Devices

Weekly program setting

Weekly ON/OFF mode

(E.g.) Output 1 (OUT1) is ON from Monday to Friday at 8:00 AM and OFF at 6:10 PM.

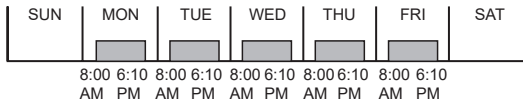

1 Advance to program 1 (P1) weekly program setting mode

SUN MON TUE WED THU FRI SAT

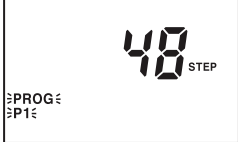

[MODE] key is pressed over 3 sec in RUN mode, **PROG P1** flashes and press [SET] key.

2 Mode type setting

SUN MON TUE WED THU FRI SAT

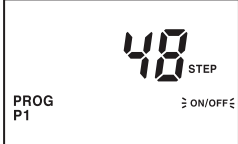

Press [SET] key in ON/OFF mode.

3 ON day setting

SUN MON TUE WED THU FRI SAT

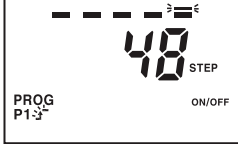

Press [▶] key to move the indicator to Monday, it will be lighted when [▲] or [▼] key are pressed and move it to Tuesday by [▶] key. Press [SET] key after Tuesday, Wednesday, Thursday, Friday turn ON.

4 ON time setting (AM, PM)

SUN MON TUE WED THU FRI SAT



[▶] key is pressed, move the flashing to hour position and select PM by [▲] or [▼] key when ON time is afternoon.

5 ON time setting (hour, min)

SUN MON TUE WED THU FRI SAT



Set 8:00 by [▲] or [▼] key and press [SET] key.

6 OFF day setting

SUN MON TUE WED THU FRI SAT

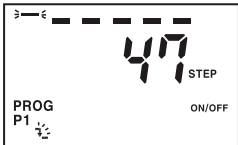

Press [SET] key to check ON/OFF day.

7 OFF time setting (AM, PM)

SUN MON TUE WED THU FRI SAT

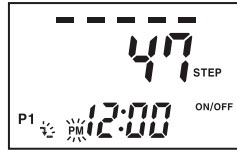

Select PM by [▲] or [▼] key and move the flashing to hour position by [▶] key.

8 OFF time setting (hour, min)

SUN MON TUE WED THU FRI SAT

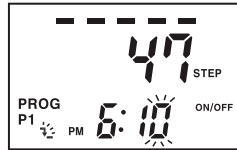

Move the flashing to minute position after set 6:00 by [▲] or [▼] key and set the minute as 10 and press [SET] key.

9 Complete to set

SUN MON TUE WED THU FRI SAT



Press [SET] key to set additional program.

Weekly pulse mode

Output 2 (OUT2) is ON for 10 sec at 8:00AM from Monday to Friday during S2 season in case, period of S1, S2, S3, S4 is set.

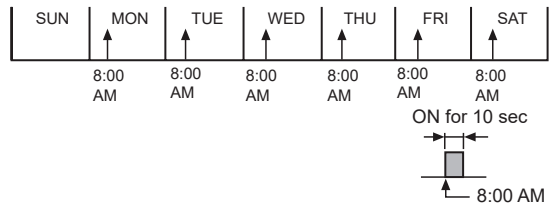

1 Program 2 (P2) advance to weekly program setting mode

SUN MON TUE WED THU FRI SAT



[MODE] key is pressed for 3 sec in RUN mode, **PROG P1** is flashed and press [MODE] key again, **PROG P2** flashes and press [SET] key.

2 Mode type setting

SUN MON TUE WED THU FRI SAT



Press [▲] or [▼] key when ON/OFF flashes, Pulse flashes and press [SET] key.

3 Season selection

SUN MON TUE WED THU FRI SAT

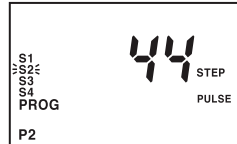

Press [▲] or [▼] key to select season S2 and press [SET] key.

Weekly/Yearly Timer

④ ON day setting

SUN MON TUE WED THU FRI SAT

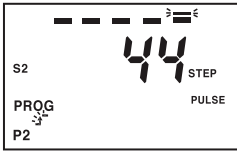

Press **▶** key to move the indicator to Monday, it will be lighted when **▲** or **▼** key is pressed and move it to Tuesday by **▶** key. Press **[SET]** key after light Tuesday, Wednesday, Thursday and Friday.

⑤ ON time setting (AM, PM)

SUN MON TUE WED THU FRI SAT



Press **▶** key, move the flashing to hour position and select PM by **▲** or **▼**

⑥ ON time setting (Hour, Min)

SUN MON TUE WED THU FRI SAT



Set 8:00 by **▲** or **▼** key and press **[SET]** key.

⑦ Pulse width setting

SUN MON TUE WED THU FRI SAT



Press **▲** or **▼** key to select pulse duration as 10s and press **[SET]** key.

⑧ Complete to set

SUN MON TUE WED THU FRI SAT

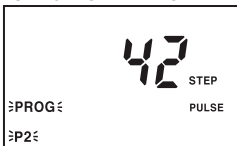

Press **[SET]** key to set additional program.

• Weekly cycle mode

(E.g.) Output 1 (OUT1) is ON for 10min and OFF for 5 min from Monday 6:00 AM to Saturday 5:30 PM. SAT

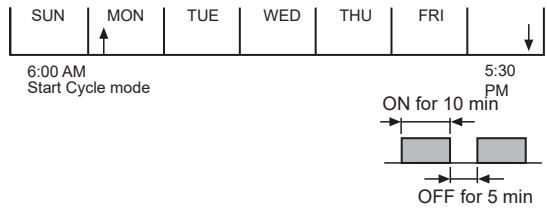

① Advance to program 1 (P1) weekly program setting mode

SUN MON TUE WED THU FRI SAT



In RUN mode, press **[MODE]** key for 3 sec and **PROG P1** flashes. Press **[SET]** key.

② Mode type setting

SUN MON TUE WED THU FRI SAT



Press **▲** or **▼** key when ON/OFF flashes, **CYCLE** flashes and press **[SET]** key.

③ to ⑧

Refer to ③ to ⑧ of "•Weekly ON/OFF mode" to set ON day, ON time, OFF day and OFF time.

⑨ ON time width setting

SUN MON TUE WED THU FRI SAT



Press **▶** key to move the flashing to minute position and set as 10 min by **▲** or **▼** key and press **[SET]** key

⑩ OFF time width setting

SUN MON TUE WED THU FRI SAT



Press **▶** key to move the flashing to minute position and set as 5 min by **▲** or **▼** key and press **[SET]** key.

⑪ Complete to set

SUN MON TUE WED THU FRI SAT



Press **[SET]** key to set additional program.

SENSORS

CONTROLLERS

MOTION DEVICES

SOFTWARE

(J) Temperature Controllers

(K) SSRs

(L) Power Controllers

(M) Counters

(N) Timers

(O) Digital Panel Meters

(P) Indicators

(Q) Converters

(R) Digital Display Units

(S) Sensor Controllers

(T) Switching Mode Power Supplies

(U) Recorders

(V) HMIs

(W) Panel PC

(X) Field Network Devices

⊙ Weekly day change

It operates when the specified day mode is required to install in other day from the set day and it returns to previous program setting automatically when it is finished. It is applied to program 1 (P1) and program 2 (P2).

● Weekly day change cancellation

- ① Change current year, month, date in current time setting mode
- ② Change standard day
- ③ Delete all program in program 1 (P1) and program 2 (P2)
- ④ Season switching

● Setting example

Output 1 (OUT1) is ON in Saturday at 9:00 AM and OFF at 12:00 PM and it is ON 8:30 AM and OFF at 6:00 PM from Monday to Friday and the mode of Monday and Tuesday is operated temporarily as Saturday (standard) program.

① Advance to weekly day change mode

SUN MON TUE WED THU FRI SAT



Press **[MODE]** key over 3 sec to move to the setting group1 in RUN mode and press it repeatedly until **C.dY** is flashed in second display part and press **[SET]** key.

② Standard day selection

SUN MON TUE WED THU FRI SAT



Press **[▶]** key to move the indicator to Saturday and press **[SET]** key. after select Saturday as standard day (SAT turns ON) by **[▲]** or **[▼]** key.

③ Change day selection

SUN MON TUE WED THU FRI SAT



Press **[▶]** key to move the indicator to Monday and select Monday to change (MON turns ON) by **[▲]** or **[▼]** key and repeat the procedure to select Tuesday to change (TUE turns ON) and press **[SET]** key to complete.

⊙ Yearly holiday mode

It operates to off the output without program adjustment during previously set yearly holiday period available from present year to 31, Dec. of the next year.

Designate the start date of yearly holiday and year of end date as every year [- -] to repeat the holiday mode for specified in every year.

● Setting example

Set every year 5, May to off the output (OUT1, OUT2).

① Advance to yearly holiday mode

SUN MON TUE WED THU FRI SAT



Press **[MODE]** key over 3sec to move to the setting group1 in RUN mode and press it repeatedly until **H.dY** flashes in second display part and press **[SET]** key.

② Yearly holiday number display

SUN MON TUE WED THU FRI SAT



Press **[SET]** key after check yearly holiday number.

③ Start date of yearly holiday setting

SUN MON TUE WED THU FRI SAT

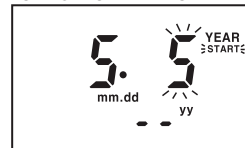

Press **[▶]** key until month position flashes and set May by **[▲]** or **[▼]** key and press **[▶]** key until date position flashes. Press **[SET]** key after set 5th by **[▲]** key.

④ End date of yearly holiday setting

SUN MON TUE WED THU FRI SAT

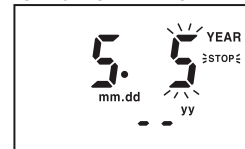

The flashing is moved to month position directly and press **[▲]** or **[▼]** key to set May and press **[▶]** key until date position flashes. Press **[SET]** key after set 5th by **[▲]** or **[▼]** key.

⑤ Complete to yearly holiday

SUN MON TUE WED THU FRI SAT



Press **[MODE]** key to finish the additional yearly holiday setting and press **[SET]** key to set .

※It is able to set yearly holiday up to 12 times.

○ Yearly program setting

● Yearly ON/OFF mode

(E.g.) Output 1 (OUT1) is ON from every 5, Apr to 7, Apr at 9:00 AM and OFF 5:10 PM.

① Advance to program 1 (P1) yearly program setting mode

SUN MON TUE WED THU FRI SAT



Press **[MODE]** key for 3 sec in RUN mode, **PROG P1** is flashed and press **[MODE]** key 3 times more until **PROG P2 YEAR** flashes and press **[SET]** key.

② Mode type setting

SUN MON TUE WED THU FRI SAT



Press **[SET]** key when ON/OFF flashes.

③ Start date setting

SUN MON TUE WED THU FRI SAT

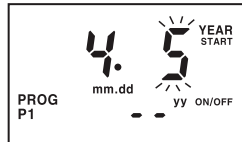

Press **[>]** key until month position flashes and set April by **[▲]** or **[▼]** key and press **[>]** key until date position flashes. Press **[SET]** key after set 5th by **[▲]** or **[▼]** key.

④ End date setting

SUN MON TUE WED THU FRI SAT

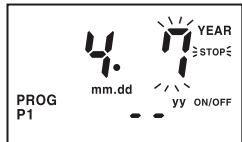

The flashing is moved to month position directly and press **[▲]** or **[▼]** key to set April and press **[▲]** or **[▼]** key until date position flashes. Press **[▲]** key after set 7th by **[SET]** key.

⑤ ON time setting (AM, PM)

SUN MON TUE WED THU FRI SAT



[>] key is pressed, move the flashing to hour position and select PM by **[▲]** or **[▼]** key when ON time is afternoon.

⑥ ON time setting (hour, min)

SUN MON TUE WED THU FRI SAT



Press **[▲]** or **[▼]** key to set 9 and press **[SET]** key after check 00min

⑦ OFF time setting (AM, PM)

SUN MON TUE WED THU FRI SAT



Select PM by **[▲]** or **[▼]** key and move the flashing to hour position by **[>]** key.

⑧ OFF time setting (hour, Min)

SUN MON TUE WED THU FRI SAT

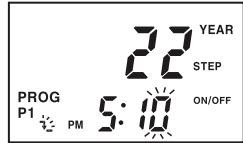

Move the flashing to minute position after set 5:00 by **[▲]** or **[▼]** key and set the minute as 10 and press **[SET]** key.

⑨ Complete to set

SUN MON TUE WED THU FRI SAT



Press **[SET]** key to set additional program.

● Yearly pulse mode

(E.g.) Output 2 (OUT2) is ON from 2, Oct, 2008 to 4, Oct, 2008 at 10:00 AM and OFF after 5 sec (present is 2007.)



① Advance to program 2 (P2) yearly program setting mode

SUN MON TUE WED THU FRI SAT



[MODE] key is pressed for 3 sec in RUN mode, **PROG P1** is flashed and press **[MODE]** key again, **PROG P2 YEAR** is flashed and press **[SET]** key.

② Mode type setting

SUN MON TUE WED THU FRI SAT



[▲] or **[▼]** key is pressed when ON/OFF flashes to set pulse mode and press **[SET]** key.

③ Start date setting

SUN MON TUE WED THU FRI SAT

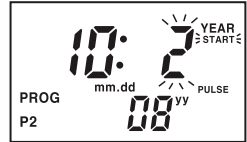

Press **[▲]** or **[▼]** key twice to set 08 (year 2008) and move to month position by **[>]** key.

Set Oct. by **[▲]** or **[▼]** key and move to date position by **[>]** key and press **[SET]** key after set 2nd by **[▲]** or **[▼]** key.

④ End date setting

SUN MON TUE WED THU FRI SAT



The flashing is moved to month position directly by **[>]** key and set 4th by **[▲]** or **[▼]** key after move it to date position by **[>]** key, then press **[SET]** key.

SENSORS
CONTROLLERS
MOTION DEVICES
SOFTWARE
(J) Temperature Controllers
(K) SSRs
(L) Power Controllers
(M) Counters
(N) Timers
(O) Digital Panel Meters
(P) Indicators
(Q) Converters
(R) Digital Display Units
(S) Sensor Controllers
(T) Switching Mode Power Supplies
(U) Recorders
(V) HMIs
(W) Panel PC
(X) Field Network Devices

⑤ ON time setting (AM, PM)

SUN MON TUE WED THU FRI SAT



▶ key is pressed, move the flashing to hour position and select PM by ▲ or ▼ key when ON time is afternoon.

⑥ ON time setting (hour, Min)

SUN MON TUE WED THU FRI SAT



Press ▲ or ▼ key twice to set 10 and press [SET] key after check 00 min

⑦ Pulse width setting

SUN MON TUE WED THU FRI SAT

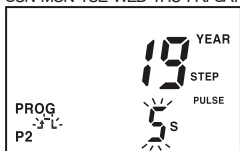

Press ▲ or ▼ key 4 times to select pulse width as 5s and press [SET] key.

⑧ Complete to set

SUN MON TUE WED THU FRI SAT

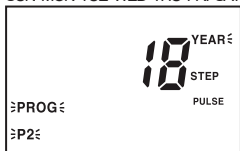

Press [SET] key to set additional program.

※ It is able to set year of start/end date in yearly program setting up to 2 years later from the present year.

■ Program Check, Modify And Delete

○ Weekly program check, modify and delete

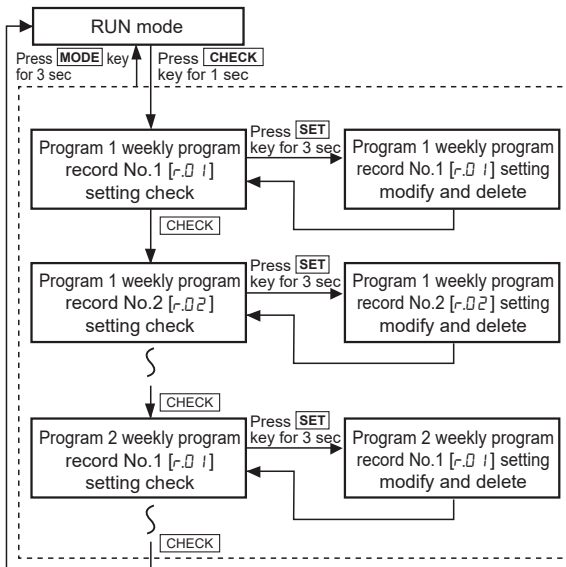

○ Yearly program check, modify and delete

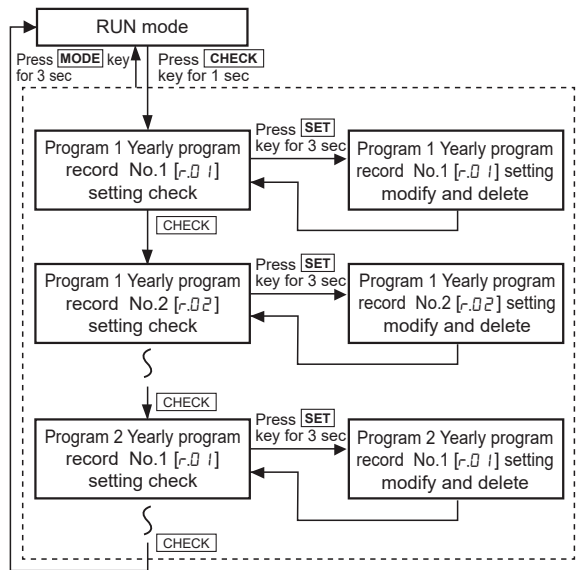

※ YEAR turns ON when check, modify or delete yearly program.

● If any key is untouched for 60 sec, it is returned to RUN mode in weekly or yearly program check.

● In weekly or yearly program check, it controls output according to program setting and output is OFF in modify or delete mode.

● When [MODE] key is pressed in weekly or yearly program record modify, delete stand by or delete mode, current work is canceled and it is returned to check mode.

● Weekly or yearly program record modify and delete

(1) Program record modify

① When press [SET] key over 3 sec in program check, *Edt* flashes in second display part, press [SET] key.

② It returns to check mode when finish the modify same as the above procedure.

(2) Program record delete

① When press [SET] key over 3 sec in program check, *Edt* flashes in second display part, press ▲ or ▼ key until *LLr* flashes in second display part and press [SET] key.

② Press *LLr* key over 3 sec when [SET] turns ON in second display part, it returns to program check.