

Temperature / Humidity Sensor



THD Series PRODUCT MANUAL

For your safety, read and follow the considerations written in the instruction manual, other manuals and Autonics website.

The specifications, dimensions, etc. are subject to change without notice for product improvement. Some models may be discontinued without notice.

Features

- Compact design
- Built-in high accuracy temperature / humidity sensor
- 7 segment LED display (THD-DD / THD-WD)
- Various output options: DC4-20mA, 1-5 VDC \pm , RS485 (Modbus RTU)
- Wide measurable range of temperature / humidity: -19.9 to 60.0 °C / 0.0 to 99.9 %RH
- Communication speed: 115200 bps

Safety Considerations

- Observe all 'Safety Considerations' for safe and proper operation to avoid hazards.
- \triangle symbol indicates caution due to special circumstances in which hazards may occur.

\triangle Warning Failure to follow instructions may result in serious injury or death.

01. Fail-safe device must be installed when using the unit with machinery that may cause serious injury or substantial economic loss. (e.g. nuclear power control, medical equipment, ships, vehicles, railways, aircraft, combustion apparatus, safety equipment, crime/disaster prevention devices, etc.)

Failure to follow this instruction may result in personal injury, economic loss or fire.

02. Do not use the unit in the place where flammable/explosive/corrosive gas, high humidity, direct sunlight, radiant heat, vibration, impact or salinity may be present.

Failure to follow this instruction may result in explosion or fire.

03. Do not connect, repair, or inspect the unit while connected to a power source.

Failure to follow this instruction may result in fire.

04. Check 'Connections' before wiring.

Failure to follow this instruction may result in fire.

05. Do not disassemble or modify the unit.

Failure to follow this instruction may result in fire.

\triangle Caution Failure to follow instructions may result in injury or product damage.

01. Use the unit within the rated specifications.

Failure to follow this instruction may result in fire or shortening the life cycle of the product.

02. Use a dry cloth to clean the unit, and do not use water or organic solvent.

Failure to follow this instruction may result in fire.

03. Keep the product away from metal chip, dust, and wire residue which flow into the unit.

Failure to follow this instruction may result in fire or product damage.

Cautions during Use

- Follow instructions in 'Cautions during Use'. Otherwise, it may cause unexpected accidents.
- Keep away from high voltage lines or power lines to prevent inductive noise. In case installing power line and input signal line closely, use line filter or varistor at power line and shielded wire at input signal line. Do not use near the equipment which generates strong magnetic force or high frequency noise.
- Install a power switch or circuit breaker in the easily accessible place for supplying or disconnecting the power.
- 24VDC \pm power supply should be insulated and limited voltage/current or Class 2, SELV power supply device.
- Do not overlapping communication line and power line. Use twisted pair wire for communication line and connect ferrite bead at each end of line to reduce the effect of external noise.
- Do not touch THD-W/D sensor part at the bottom of the sensor pole by hands. It may cause malfunction.
- THD-R must be installed on the wall. It may cause malfunction.
- Make a required space around the unit for radiation of heat. For accurate temperature measurement, warm up the unit over 20 min after turning on the power.
- Make sure that power supply voltage reaches to the rated voltage within 2 sec after supplying power.

- Do not wire to terminals which are not used.
- This unit may be used in the following environments.
 - Indoors (in the environment condition rated in 'Specifications')
 - Altitude max. 2,000 m
 - Pollution degree 2
 - Installation category II

Ordering Information

This is only for reference.
For selecting the specified model, follow the Autonics website.

THD - ① ② ③ - ④

① Mounting type

R: Room type (for indoor)
D: Duct mounting type
W: Wall mounting type

② Display

No mark: Non-display type
D: Display type

③ Sensor pole length

No mark: Built-in type
1: 100 mm
2: 200 mm

④ Output

	Temperature	Humidity
C	Current output	
V	Voltage output	
T	RS485 communication output	
PT	DPT100.Ω resistance value	-
PT/C	DPT100.Ω resistance value	Current output

Product Components

- Product
- Instruction manual
- Bracket (THD-W / D model)

Software

Download the installation file and the manuals from the Autonics website.

■ DAQMaster

DAQMaster is comprehensive device management program. It is available for parameter setting, monitoring.

Dimensions

- Unit: mm, For the detailed drawings, follow the Autonics website.

■ THD-R

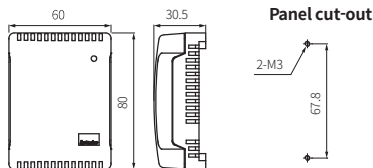

■ THD-D

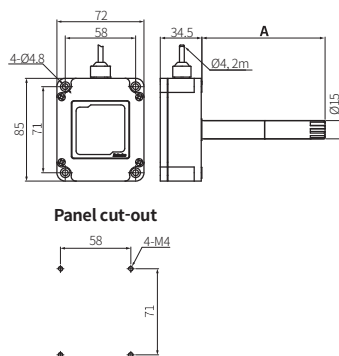

■ THD-W

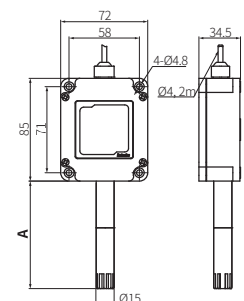

Model	Sensor pole length (A)
THD-□1-□	100 mm
THD-□2-□	200 mm

■ Bracket

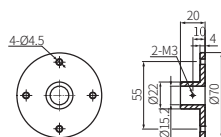

Connections

- Check the terminal connection diagram and be careful with connecting the power.

■ THD-R

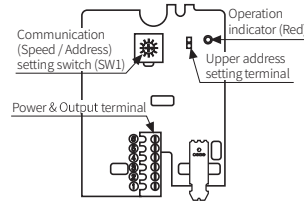

■ THD-D / THD-W

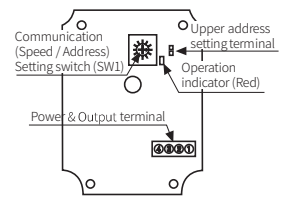

THD-R-C, V, T

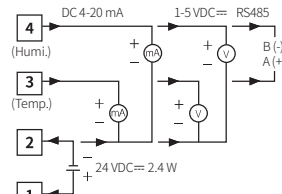

THD-□-C

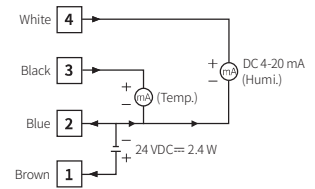

THD-R-PT

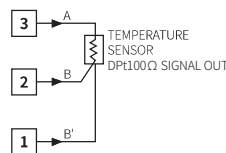

THD-□-V

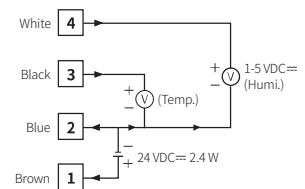

THD-R-PT/C

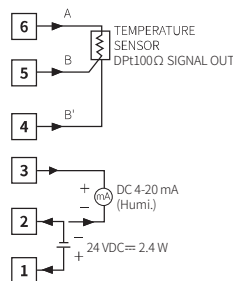

THD-□-T

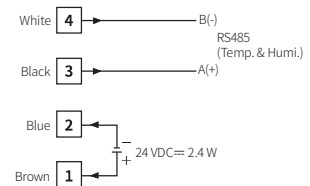

Case Detachment

- When setting communication, turn off the power, remove the case cover, and operate the communication setting switch to set the communication address and speed. Refer to 'RS485 Communication' for the details.

■ THD-R

- Unfasten the bolt on the bottom of the product, separate the case from it.

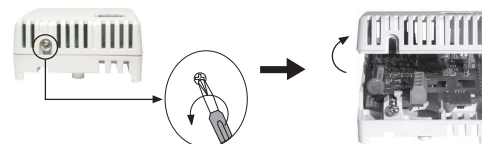

■ THD-D / THD-W

- Unfasten 4 bolts on the top of the product, separate the case cover from it.

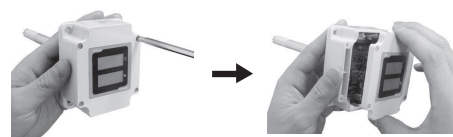

Specifications	
Model	THD-R-PT
Sensor type	Temperature sensor
Display type	Non-display type
Temp. measuring range	-19.9 to 60.0 °C
Temp. accuracy	± 0.8 °C
Temp. output	DPT100Ω resistance value (TCR: 3850 ppm/°C)
Protection structure	IP10 (IEC standards)
Ambient temperature	-20 to 60 °C, Storage: -20 to 60 °C (rated at no freezing or condensation)
Approval	CE ENEC

Model	THD-R-PT/C	THD-R-C THD-R-V THD-R-T	THD-D□-□ THD-W□-□	THD-DD□-□ THD-WD□-□
Power supply	24 VDC± ±10 %			
Power consumption	≤ 2.4W			
Sensor type	Temperature/Humidity Sensor			
Display type	Non-display type			7 seg. LED display
Display digit	-			Each 3 digits for temp. / humi.
Temp. measuring range	-19.9 to 60.0 °C			
Humi. measuring range	0.0 to 99.9 %RH (THD-R is required to attend for using over 90 %RH)			
Temp. accuracy	± 1.0 °C (at room temp.)			
Humi. accuracy	± 3 %RH (30 to 70 %RH, at room temp.) ± 4 %RH (10 to 90 %RH)	Typ. ±2 %RH (10 to 90 %RH, at room temp.) ≤ ± 2.5 %RH		
Temp. output	DPT100Ω resistance value (TCR: 3850 ppm/°C)	DC 4-20 mA (allowable impedance: ≤ 600 Ω), 1-5 VDC±, RS485 Communication (Modbus RTU)		
Humi. output	DC 4-20 mA (allowable impedance: ≤ 600 Ω)			
Resolution	1/1000			
Sampling period	0.5 sec			
Insulation resistance	≥ 100 MΩ (500 VDC± megger)			
Dielectric strength	500 VAC ~ 50/60 Hz for 1 min			
Noise immunity	±0.3 kV the square wave noise (pulse width: 1 μs) by the noise simulator			
Vibration	0.75 mm amplitude at frequency of 10 to 55 Hz (for 1 min) in each X, Y, Z direction for 1 hour			
Vibration (Malfunction)	0.5 mm amplitude at frequency of 10 to 55 Hz (for 1 min) in each X, Y, Z direction for 1 hour			
Shock	300 m/s ² (≈ 30 G) in each X, Y, Z direction for 3 times			
Shock (Malfunction)	100 m/s ² (≈ 10 G) in each X, Y, Z direction for 3 times			
Protection structure	IP10 (IEC standards)	IP65 (except sensor part, IEC standards)		
Ambient temperature	-20 to 60 °C, Storage: -20 to 60 °C (rated at no freezing or condensation)			
Cable spec.	-	Ø4 mm, 4-wire, length: 2 m		
Wire spec.	-	AWG22 (0.08 mm, 60-wire), Insulator diameter: Ø1.25 mm		
Approval	CE ENEC (only for THD-□-T model) ENEC			

Communication Interface

■ RS485

Comm. protocol	Modbus RTU
Application standard	Compliance with EIA RS485
Max. Connection	31 units (address: 01 to 31)
Synchronous method	Asynchronous
Comm. method	2-wire half duplex
Comm. distance	< 800 m
Comm. speed	1200 to 115200 bps (selectable)
Start bit	1 bit (fixed)
Data bit	8 bit (fixed)
Parity bit	None (fixed)
Stop bit	1 bit (fixed)

- It is not allowed to change parameter related to THD communication under the communication with high order system. (THD and upper system are available to change the address at communication status.)
- Match the parameter of THD communication to be same as the high order system.
- It is not allowed to set overlapping communication address at the same communication line. Use twisted pair wire which is appropriate communication cable for RS485 communication.

Functions

■ Current output

- It transmits current temperature and humidity to other devices (PC, recorder, etc.) and outputs DC 4-20 mA.
- The temperature and humidity output are separated and the resolution is divisible by 1,000.

Temperature	Humidity	Voltage Output
-19.9 °C	0.0 %RH	DC 4 mA
60.0 °C	99.9 %RH	DC 20 mA

■ Voltage output

- It transmits current temperature and humidity to other devices (PC, recorder, etc.) and outputs 1-5 VDC±.
- The temperature and humidity output are separated and the resolution is divisible by 1,000.

Temperature	Humidity	Voltage Output
-19.9 °C	0.0 %RH	1 VDC±
60.0 °C	99.9 %RH	5 VDC±

■ DPT100Ω resistance value output

- It transmits current temperature to other devices (recorder, thermometer, etc.).
- Temperature coefficient (TCR) = 3850 ppm/°C

Temperature	Resistance value output
0.0 °C	100 Ω
50.0 °C	119.40 Ω

RS485 Communication

■ Ordering of communication control

- The communication method is Modbus RTU.
- After 2.0 sec supplying the power into master system, it is able to start communication.
- The initial communication is started by master system. When a command comes out from the master system, THD will respond.

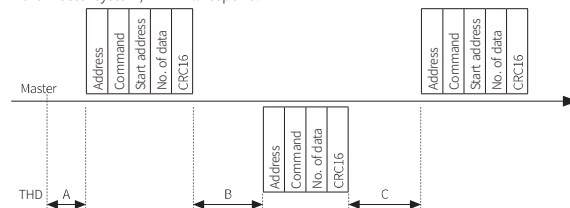

- A → Min. 2.0 sec after supplying power
- B → (Communication Speed × 10) × within 10 times
e.g. (1 s / 9600 bit × 10 bit) = 1.04 ms × within 10 times
- C → (Communication Speed × 10) × over 4 times

■ Communication speed setting

- Turn off the power of the unit.
- Set SW1 to 0 and supply the power.
- Operation indicator LED is flashing.
- Set a communication speed after choosing SW1 within the range 1 to 8, and hold it for 3 sec.
- After 3 sec and operation indicator is ON, turn OFF the power.

SW1	Comm. speed (bps)
1	1200
2	2400
3	4800
4	9600 (factory default)
5	19200
6	38400
7	57600
8	115200

■ Communication address setting

- Set upper address setting terminal and setting switch (SW1) to the desired address and supply the power.
- The communication address is changed automatically.

Address	Upper address setting terminal	SW1	Address	Upper address setting terminal	SW1
01	OPEN	1 (factory default)	16	SHORT	0
02	OPEN	2	17	SHORT	1
03	OPEN	3	18	SHORT	2
04	OPEN	4	19	SHORT	3
05	OPEN	5	20	SHORT	4
06	OPEN	6	21	SHORT	5
07	OPEN	7	22	SHORT	6
08	OPEN	8	23	SHORT	7
09	OPEN	9	24	SHORT	8
10	OPEN	A	25	SHORT	9
11	OPEN	B	26	SHORT	A
12	OPEN	C	27	SHORT	B
13	OPEN	D	28	SHORT	C
14	OPEN	E	29	SHORT	D
15	OPEN	F	30	SHORT	E
-	-	-	31	SHORT	F

■ Modbus mapping table

Address	Description	Note
300001 (0000)	Temperature value	Value×0.01
300002 (0001)	Humidity value	Value×0.01